

getmore 010.2936

Data cabling with integrated power installations

- Data and power installations solutions
- Neat and protected cable routing up to the workplace
- Modular connections boxes for individual requirements
- Modern design crowned with absolute functionality

@ R&M

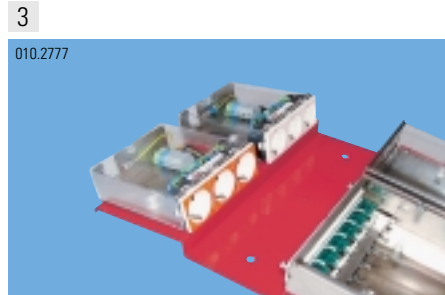
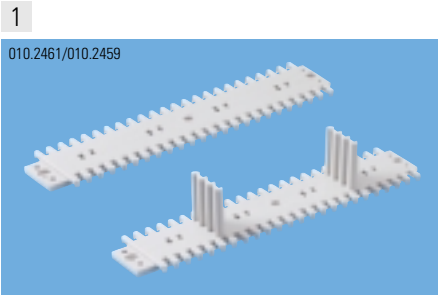

Products	Page
1 Cable Tie Shelf	100
2 Cable Outlet, CO	102
Bus Outlet	108
3 FB COMBIbox/DOUBLE DESKbox	109

Products	Page
4 INTERbox for INTERCELL Cabling Floors	111
Cable Outlet for Hollow Floors	112
5 FLEXkanal, Flexible Wiring Duct	114
Cable Management Panel	116
6 DESKbox	117

Cable Tie Shelf

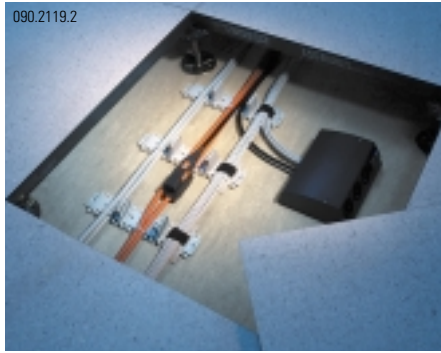

We supply a complete system solution for office cabling systems.

Installation and applications

The 25 cm long plastic rail can be linked together to form any required length. It is fastened with screws inserted in the pre-punched holes. The screw heads are countersunk in the rails when tightened so that the cable cannot be damaged when being installed. The cable tie shelf is also very practical in riser zone cabling; the cables are easily fastened with cable ties, which is particularly advantageous with sensitive low-current and coax cables. The separator and the cable bridge are two handy additions, for use with all cable tie shelves. They are simply snapped into place anywhere on the cable tie shelf. The practical and simple clamp system requires no additional fastening means.

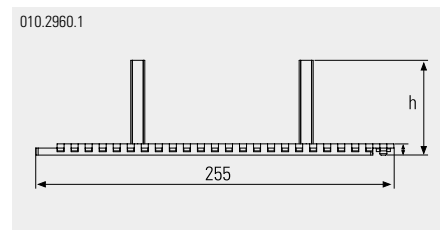

Cable tie shelf, flat

Without separator 8 mm
With separator 30, 45, 68 mm

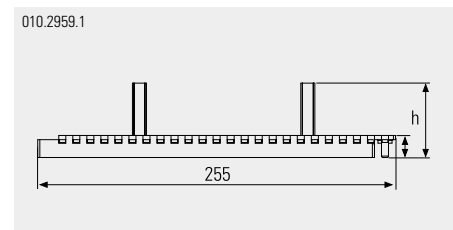

Cable tie shelf, raised

Without separator 15 mm
With separator 37, 52, 75 mm

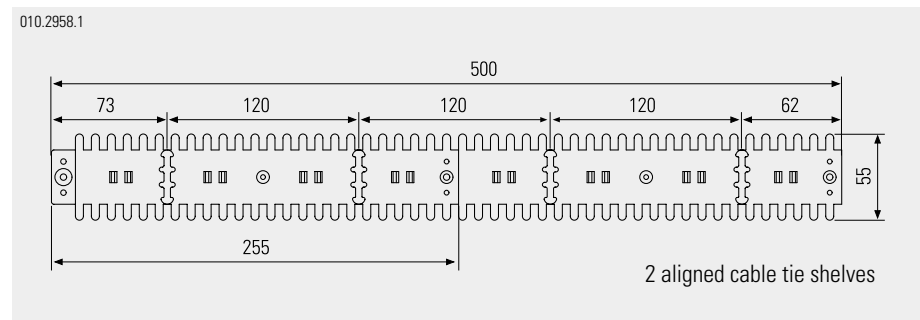

Ordering Information

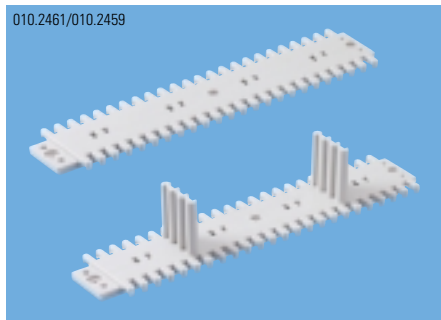

Description	Packing Unit	Part Number
Cable Tie Shelf Convenient routing of cable bundles in surface installations in hollow floors and riser zones.		
Cable Tie Shelf, flat		
Cable Tie Shelf, 8 mm Cable tie shelf without separators.	100	R307367
Cable Tie Shelf, 30 mm Cable tie shelf (height 8 mm) with separators (height 22 mm).	100	R307369
Cable Tie Shelf, 45 mm Cable tie shelf (height 8 mm) with separators (height 37 mm).	100	R307370
Cable Tie Shelf 68 mm Cable tie shelf (height 8 mm) with separators (height 60 mm).	100	R307371

Ordering Information	Description	Packing Unit	Part Number
 <p>010.2465/010.2463</p>	Cable Tie Shelf, raised	50	R307372
	Cable Tie Shelf, 15 mm Cable tie shelf, without separators.	50	R307374
	Cable Tie Shelf, 37 mm Cable tie shelf (height 15 mm) with separators (height 22 mm).	50	R307375
	Cable Tie Shelf, 52 mm Cable tie shelf (height 15 mm) with separators (height 37 mm).	50	R307376
	Cable Tie Shelf, 75 mm Cable tie shelf (height 15 mm) with separators (height 60 mm).		
 <p>010.2668</p>	Separator, 45 mm, for Cable Tie Shelf Can be snapped into place anywhere on the cable tie shelf. Separator is snapped on (height 37 mm).	100	R307365
 <p>010.2475</p>	Cable Bridge for Velcro Tape Fixing Used for direct surface mounting or snapped into place anywhere on the cable tie shelf. Ideal for fiber optic cables. There is no risk of squeezing.		
	Cable Bridge without Velcro Tape	50	R307431
	Cable Bridge with 20 cm Velcro Tape Including 20 cm of Velcro tape.	50	R307429
 <p>010.2474</p>	Velcro Tape 5 m To group and stabilize pressure-sensitive data and fiber optic cables. Dimensions: 5 m x 20 mm x 1 mm (L x W x D)	1	R307433

**RCO power
Cable Outlet 3-pole**



The smart solution for interruption-free termination to round power cables



- Two wired outlets in 40 seconds
- Tool-free IDC* contacting
- Integral connector locking
- For use with all customary round cables
- Mechanical and visual coding

* Insulation Displacement Contact

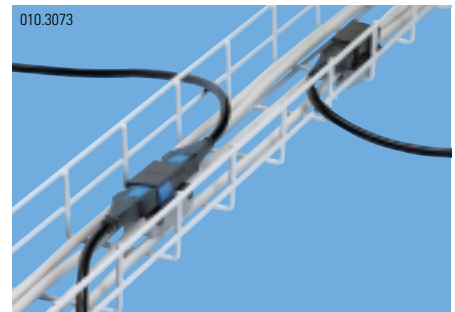
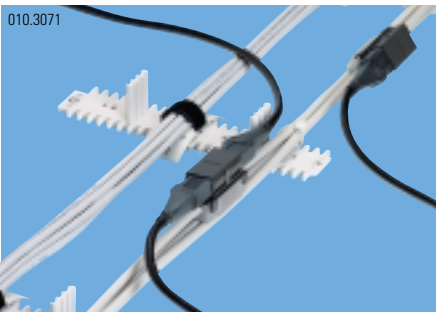

The wiring is performed in seconds and no additional tools are needed – in floor, duct and ceiling installations – these are the benefits of the new 3-pole Cable Outlet, also for your next project.

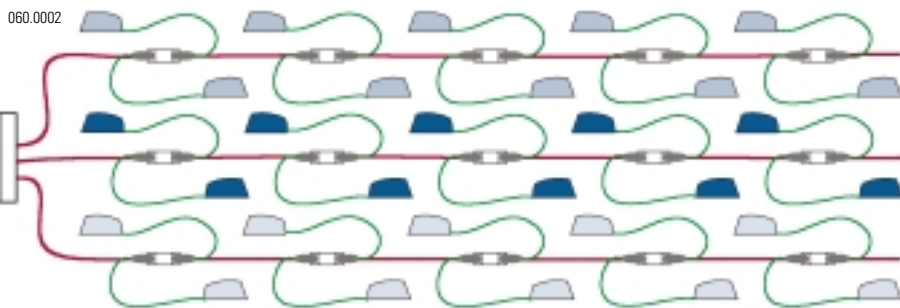

RCO Power also shines in double floor installations. Ideally, the connection boxes are fitted with RCO Power connection cables, and when being positioned, two of the boxes are each plugged to an adapter. The integral plug bolt prevents any accidental unplugging.

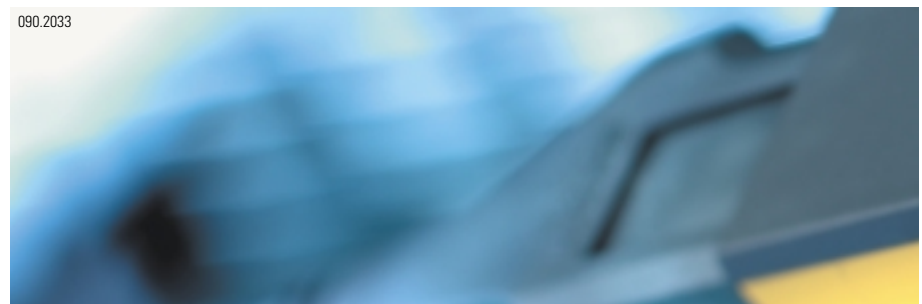

Ordering Information

Description

Packing Unit

Part Number



010.3229

CO Round Cable Adapter, 3 x 1.5–2.5 mm²

Adapter with two 3-pole outlets. For mounting to a round cable 3 x 1.5–2.5 mm² (single wire). Labels are available in different colors to identify and mark the different electric circuits. The round cable adapter is ready for mechanical 4-stage coding.

Approved: 250 V/16 A
Dimensions: 71 x 32 x 37 mm

10

R309842

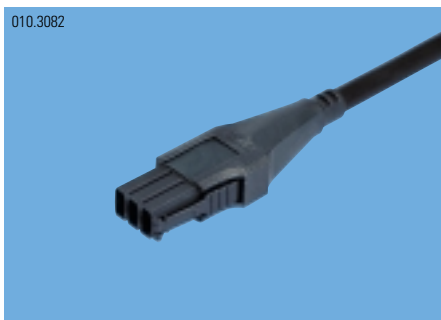

010.3082

CO Connection Cable 3 x 1.5 mm² PVC, with plug

Cable 3 x 1.5 mm², pre-assembled with 3-pole, molded plug. Open wire end. Strand ends ultrasonically sealed.

Cable jacketed: PVC, black

Length [L]:

0.5 m	10	R308206
1.0 m	10	R309435
2.0 m	10	R308209
3.0 m	5	R309437
5.0 m	5	R309438
8.0 m	3	R309764

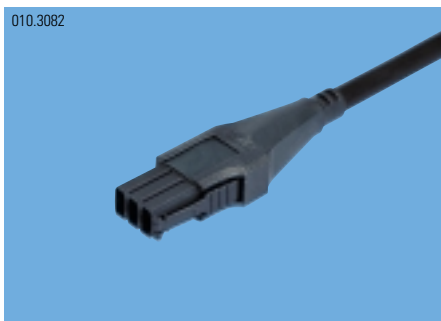

010.3082

CO Connection Cable 3 x 1.5 mm² halogen-free, with plug

Cable 3 x 1.5 mm², pre-assembled with 3-pole, molded plug. Open wire end. Strand ends ultrasonically sealed.

Cable jacket: PVC, halogen-free, black

Length [L]:

0.5 m	10	R309765
1.0 m	10	R309766
2.0 m	10	R309767
3.0 m	5	R309768
5.0 m	5	R309769
8.0 m	3	R309770

060.0005

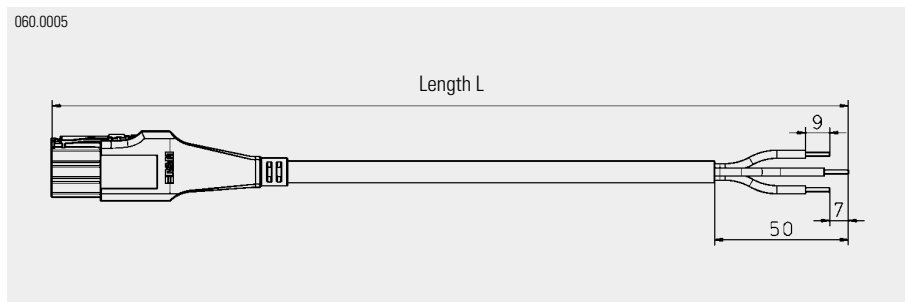

**RCO power
Cable Outlet 3-pole
Accessories**

Ordering Information

Description

Packing Unit

Part Number

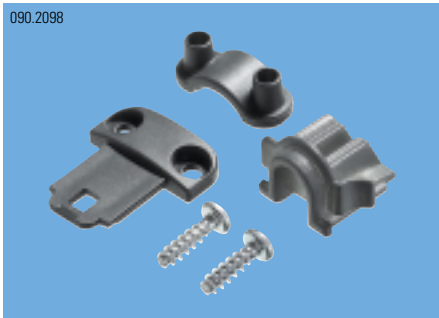

CO Safe Cap for Round Cable Adapter

10

R309059

Can be snapped on to either side. For a safe termination of the round cable to the 3-pole round cable adapter at the cable end. The opposite end must be fitted with a strain relief. Strain relief supplied.



CO Strain Relief for Round Cable Adapter

10

R309867

Can be snapped on to either side. For cables of diameter 6.5–10.5 mm.

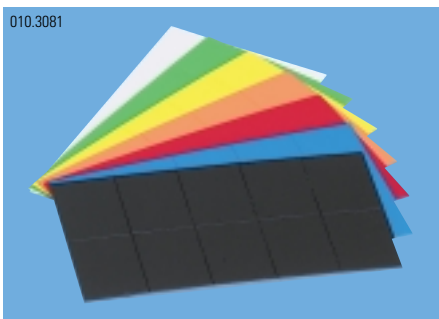

CO Sheet of 10 Labels

Plastic labels for CO round cable adapters 3 x 1.5–2.5 and CO plugs. For use with permanent felt-tip pen or stickers. A range of colors is available for the visual identification of different electric circuits, such as the normal power grid, UPS group, controlled groups, etc.

White	10	R309718
Green	10	R309722
Yellow	10	R309723
Orange	10	R309720
Red	10	R309724
Blue	10	R309721
Black	10	R309719

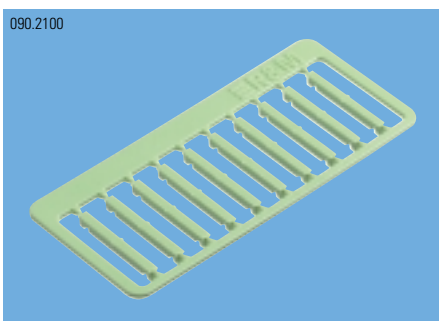

CO Coding Set of 10 Pins, green

10

R309973

Mechanical coding ensures that equipment groups can only be plugged into outlets in the correct circuits.

Coding System

Plug \ Adapter	Adapter			
	060.0020	060.0021	060.0022	060.0023
060.0016	accepted	blocked	blocked	blocked
060.0017	accepted	accepted	blocked	blocked
060.0018	accepted	blocked	accepted	blocked
060.0019	accepted	accepted	accepted	accepted



090.2117

Cable Outlet Connection, 5-pole/400 V-16 A

For the interruption-free termination of several CO adapters to a round cable with solid conductors of 5 x 2.5 mm². The wires are mounting in the well-proven insulation displacement contact technology without causing any interruption. Ideal for cable ducts, hollow ceilings and hollow floors. The resulting installation is very flexible. The various colors of the cable covers the identification of different electric circuits, for a safe termination. For floating connections, it is mandatory to lock the connectors (VDE standard). We recommend using the required plug bolts with all applications.

Ordering Information

Description

Packing Unit

Part Number



010.2536

**Cable Outlet Adapter, 5-pole
Type A54.1/400 V-16 A**

Branch point for round cables with solid conductors of 5 x 2.5 mm². Terminated in 40 seconds in the proven IDC technology.

Approved: 400 V/16 A

CO Adapter, gray

1

R307475

CO Adapter, black

1

R307779

CO Adapter, orange

1

R307782

CO Adapter, blue

1

R307780

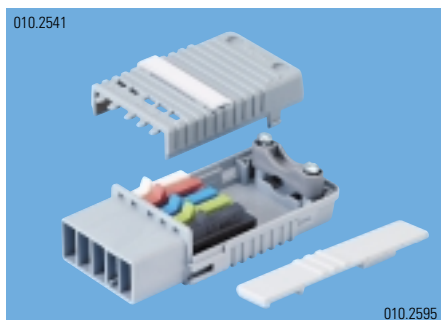

010.2541

**Cable Outlet Plug, complete
Type S54.1/400 V-16 A**

Field-terminated plug for CO adapters, 5-pole, type A54.1. The enclosure includes strain relief and plug pins for the termination of stranded cables of 3 x 1.5 mm²–5 x 2.5 mm². Plug bolt also supplied.

Approved: 400 V/1A

CO Plug for 3 x 1.5 mm²

25

R307479

CO Plug for 5 x 1.5 mm²

25

R307481

CO Plug for 3 x 2.5 mm²

25

R307480

CO Plug for 5 x 2.5 mm²

25

R307482

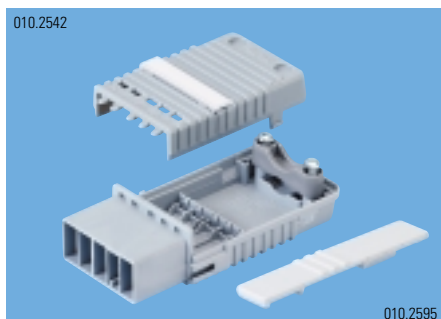

010.2542

**Cable Outlet Plug Housing, empty
Type S54.1/400 V-16 A**

Empty housing, accommodating 3–5 connector pins. Plug bolt also supplied.

25

R307484

RCO power
Cable Outlet 5-pole

Ordering Information

Description

Packing Unit

Part Number

010.2592

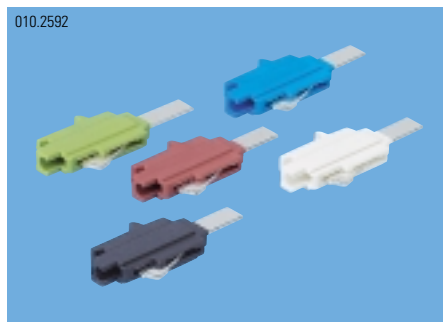

Connector Pins for the CO Plug Housing S54.1

For the insulation displacement connection of strands. The wiring can be visually checked through the side window.

For 1.5 mm² strands

CO Connector Pin, PE yellow/green	10	R307485
CO Connector Pin, N light blue	10	R307486
CO Connector Pin, L1 black	10	R307487
CO Connector Pin, L2 brown	10	R307488
CO Connector Pin, L3 white	10	R307489

For 2.5 mm² strands

CO Connector Pin, PE yellow/green	10	R307490
CO Connector Pin, N light blue	10	R307491
CO Connector Pin, L1 black	10	R307492
CO Connector Pin, L2 brown	10	R307493
CO Connector Pin, L3 white	10	R307494

010.2587



Cable Outlet Plug 5-pole, Type S54.1/ 400 V-16 A, pre-assembled with cable

For a fast on-site installation, the S54.1 plug can be ordered assembled with cables of different lengths and types. The cable end for standard cables is left unprocessed. Phase assignment is clearly visible through the window. All plugs come supplied with a plug bolt.

010.2586





Plug Type S54.1, pre-assembled with flexible cable (PVC) 3 x 1.5 mm², black. Connection phase on L1. Cable end unprocessed.

0.5 m	1	R307715
1.0 m	1	R307716
2.0 m	1	R307717
3.0 m	1	R307718
5.0 m	1	R307719

Plug Type S54.1, pre-assembled with flexible cable (PVC) 5 x 1.5 mm², black. Connection phase on L1, L2, L3. Cable end unprocessed.

0.5 m	1	R307721
1.0 m	1	R307722
2.0 m	1	R307723
3.0 m	1	R307724
5.0 m	1	R307725

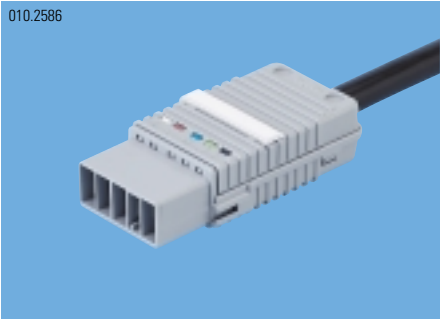
i On request we also assemble CO plugs for other cable types and lengths. The wire ends can be supplied tin-coated or capped with sleeves.

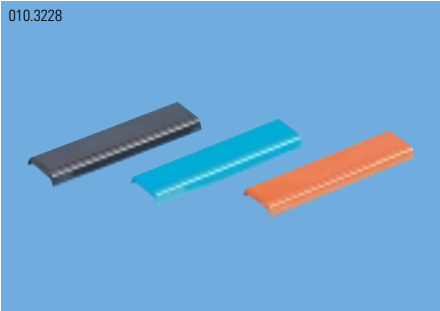
Ordering Information	Description	Packing Unit	Part Number
010.2586 	Plug Type S54.1, pre-assembled with flexible cable (PE compound halogen-free) 3 x 1.5 mm ² , gray. Connection phase on L1. Cable end unprocessed.		
	0.5 m	1	R307726
	1.0 m	1	R307727
	2.0 m	1	R307728
	3.0 m	1	R307729
	5.0 m	1	R307730
	Plug Type S54.1, pre-assembled with flexible cable (PE compound halogen-free) 5 x 1.5 mm ² , gray. Connection phase on L1, L2, L3. Cable end unprocessed.		
	0.5 m	1	R307732
	1.0 m	1	R307733
	2.0 m	1	R307734
3.0 m	1	R307736	
5.0 m	1	R307737	
	Cable Outlet Labels (qty 220) For CO adapters and plugs. In A4 format, printable.	1	R307501
010.2477 	CO Plug, 5-pole, complete, for 3-pole Wieland (Gesis)	1	R307896
010.2577 	Cable Outlet Multiplug, 5-pole, complete, for 3 x 3-pole Wieland (Gesis)		
	CO Multiplug 3 x 3 pole/parallel L1	1	R307496
	CO Multiplug 3 x 3 pole/ parallel L2	1	R307497
	CO Multiplug 3 x 3 pole/parallel L3	1	R307498
	CO Multiplug 3 x 3 pole/L1-L2-L3, black	1	R307499
	CO Multiplug 3 x 3 pole/L1-L2-L3, white	1	R307500
	CO Labels (qty 99) for CO Multiplugs	1	R307784
010.3228 	CO Label Clips S54.1/A54.1 Hard plastic labels for CO adapters of type A54.1 and CO plugs of type 54.1. For use with permanent felt-tip pen or stickers. A range of colors is available for the visual identification of different electric circuits, such as the normal power grid, UPS group, controlled groups, etc.		
	CO Label Clip, black	10	R310738
	CO Label Clip, blue	10	R310736
	CO Label Clip, orange	10	R310737

**RCO power
Bus Outlet
Accessories**

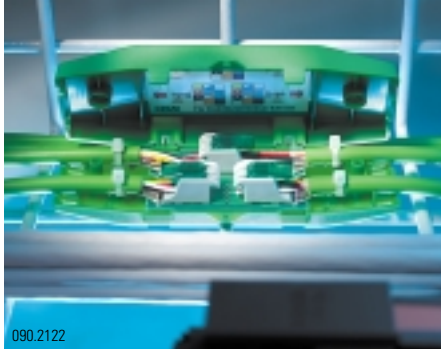

Bus Outlet

Outlet or tapping box for bus cables of 4 x 0.8 mm.
Dimensions: 130 x 46 x 22 mm.

Ordering Information

Description

Packing Unit

Part Number



090.2113

Bus Outlet "easy-2", shielded

Box for 1 x bus cable and 2 x connection cables
4 x 0.8 mm².

10

R311818

Bus Outlet Labels (qty 110)

110 laser labels. In A4 format (12.7 x 35.56 mm).

1

R307714

Accessories



010.3230

RCO Power Cable Stripper

Opening cable jackets fast and easily. For cable
diameters of 4–16 mm.

1

R307581

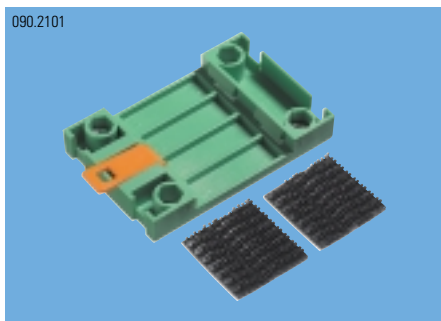

090.2101

RCO DIN Top Hat Rail Mounting

Kit to mount CO adapters of type A54.1, CO round
cable adapters, 3 x 1.5–2.5 mm² and "easy-2" bus
outlets, shielded, onto DIN 35 top hat rails.

1

R311559

010.2777

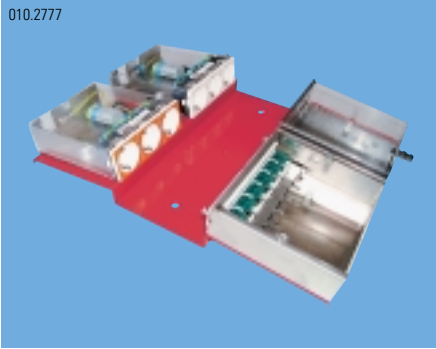

FB COMBIbox

These floorboxes (dimensions 156 x 135 x 48, length x width x depth) are easily mounted and positioned. Their base plates are made of stainless steel, the cover, made of transparent polycarbonate, is snapped on. They are ideal for a range of applications also for their generous spatial arrangement. The choice of different bases ensures a user-friendly and solid positioning.

Ordering Information

Description

Packing Unit

Part Number

010.2443

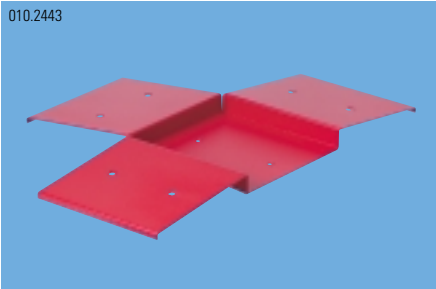

FB COMBIbox, 3-Position Base, T-Shape, red

1

R307813

T-shape base holding 3 COMBIboxes.
Sheet steel, powder-coated, red.
Dimensions: 180/345 x 510 x 28/5 mm
(L x W x D/H)

010.2444

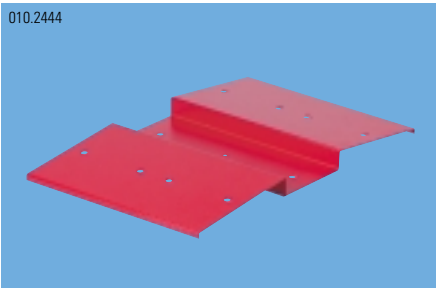

FB COMBIbox, 4-Position Base, parallel, red

1

R307814

For 2 COMBIboxes each in a parallel arrangement.
Sheet steel, powder-coated, red.
Dimensions: 440 x 270 x 28/5 mm (L x W x D)

090.2095



FB COMBIbox 3 x Schuko, white

1

R307809

Assembled with 3 jacks, Schuko/white, and wired to terminals (L1/N/PE). 2 cable entries, one mounted with a M20 stuffing box.

i On request all the boxes are supplied equipped and wired.

FB COMBIbox Mounting Options Module 45							
Schuko	Type 13						
090.2089	090.2091						
◊ ◆ ◆ ◆	◊ ◆ ◆						

**FB COMBIbox
DOUBLE-DESKbox**

Ordering Information

Description

Packing Unit

Part Number

010.2484

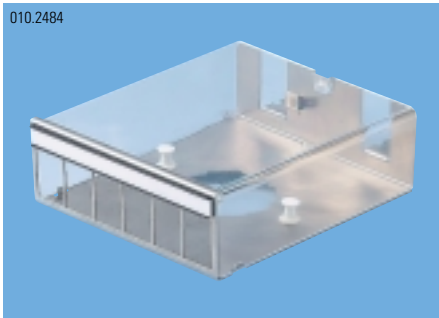

FB COMBIbox, for 6 RJ45, empty

Data outlet for 6 RJ45 R&Mfreenet modules.
Two cable entries with strain relief lug (without module holder and modules).

1

R307810

010.2556

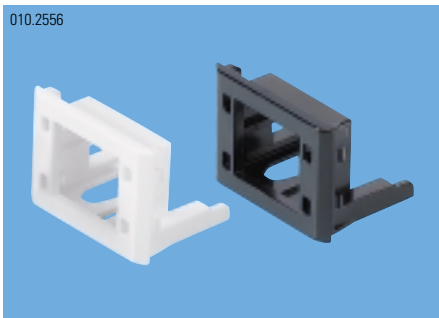

Module Holder for RJ45 R&Mfreenet

Module holder for RJ45-R&Mfreenet modules
Material: halogen-free plastic

Module Holder RJ45, white
Module Holder RJ45, black

10
10

R307832
R307833

010.2729

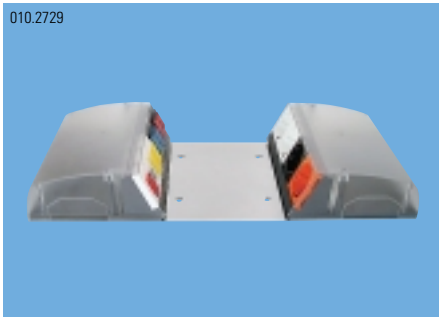

DOUBLE DESKbox

Aluminum base plate. 2 clear DESKboxes (halogen-free polycarbonate). Each box accommodates four 45 x 45 mm modules, which corresponds to 4 sockets or 8 data outlets RJ45.
Dimensions: 425 x 185 x 61 mm

i On request all the boxes are supplied equipped and wired

DOUBLE DESKbox Mounting Options Module 45					Accessories	
Schuko	Type 13	Belgian/ French	British	RJ45 faceplates	Connection modules	FO adapters
090.2089	090.2091	090.2088	090.2090	010.2574.1	010.2859	020.0070
◇ ◆ ◆ ◆	◇ ◆ ◆	◇	◇	◇ ◆	010.2857	010.2158
					Page 36/37	Page 46



INTERbox

The electrical box for a compact and flexible installation of the INTERCELL cable management cabling floor system.

Material: stainless steel base plate, plastic cover (halogen-free).

Dimensions: 156 x 135 x 48 mm (L x W x D).

Ordering Information

Description

Packing Unit

Part Number

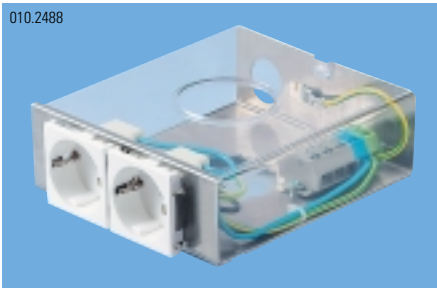

010.2488

INTERbox, assembled

Assembled with 2 sockets, Schuko/white, horizontally wired to terminals (L1/N/PE). 2 cable entries, one mounted with a M20 stuffing box. Ideal for use with 60 mm elbow connectors.

1

R307815



090.2094

INTERbox, assembled

Assembled with 3 sockets, Schuko/white, wired to terminals (L1/N/PE). 2 cable entries, one mounted with a M20 stuffing box. Not for use with 60 mm elbow connectors.

1

R307816

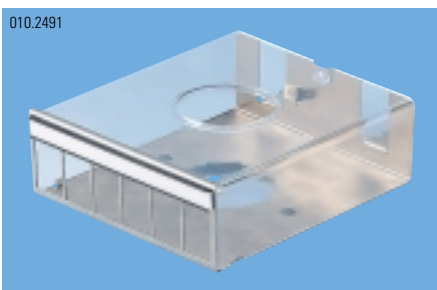

010.2491

INTERbox, for 6 RJ45, empty

Data outlet for 6 x RJ45 R&Mfreenet modules. 2 cable entries, both with strain relief lug (without modules and module holder).

1

R307818

i On request all the boxes are delivered equipped and wired.

INTERbox Mounting Options Module 45						Accessories	
Schuko	Type 13					Connections modules	FO adapters
090.2089	090.2091					010.2859	020.0070
						010.2857	010.2158
						Page 36/37	Page 46

Floor Outlet for Double Floors



Floor Outlet for Double Floors

Ideal access opening for the central CP or direct connection point at the workplace.

Ordering Information

Description

Packing Unit

Part Number

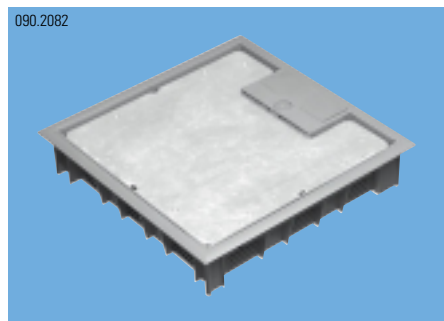

Floor Cable Outlet Cable 282 x 282

Cable outlet consisting of a mounting unit incl. carpet protection frame and hinged cover. For surfaces of 5 mm. Cutout dimensions: 264 x 264 mm

1

R311828

Floor Cable Outlet Cable 225 x 225

Cutout dimensions: 209 x 209 mm

1

R311829

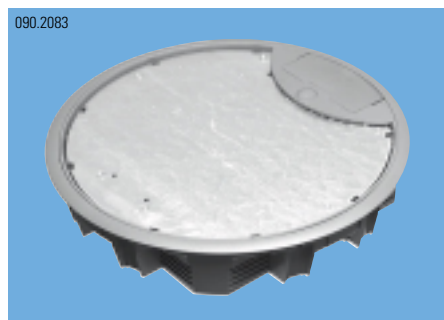

Floor Cable Outlet Cable Ø 325 mm

Cutout dimensions: diameter 305 mm

1

R311830



Cable Passage for Double Floors

Made up of a cable outlet with an inner diameter of 68 mm and a slotted insert to lead the cable through.

Passage bore: 76 mm in diameter
Height: 44 mm

Cable Passage

81 x 44 mm, anthracite RAL 7024

10

R307583

Cable Passage

81 x 44 mm, light gray RAL 7035

10

R307584

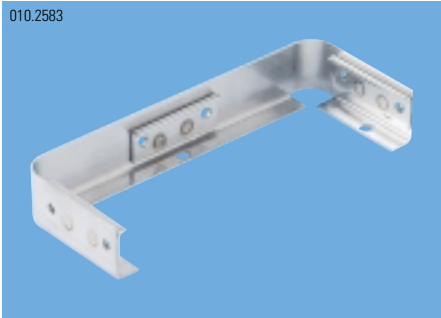
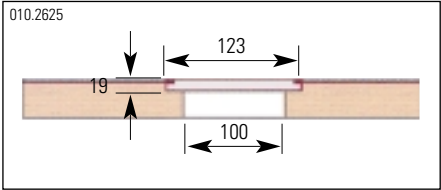
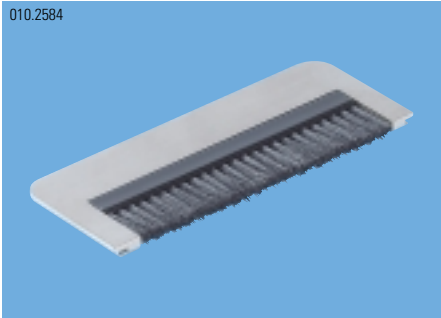
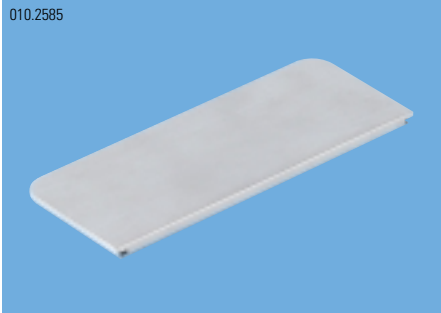
Ordering Information	Description	Packing Unit	Part Number
<p>010.2583</p> 	<p>Cable Passage for Double Floors Consisting of a frame and a brush or blind insert.</p> <p>Holder for Cable Passage Holder made of stainless steel featuring 3 fastening holes.</p>	1	R307826
<p>010.2625</p> 	<p>Cutout dimensions: 123 x 46.5 x 19 mm at a rear radius of 9 mm and 100 x 35 mm with wall openings.</p>		
<p>010.2584</p> 	<p>Cable Passage Insert with Brush Stainless steel insert with brush, to slide in from the side. Steel gray chromated. Dimensions: 120 x 45 x 4 mm</p>	1	R307824
<p>010.2585</p> 	<p>Cable Passage Aluminum Blind Insert Aluminum insert to slide in from the side to serve as blind cover. Steel gray chromated. Dimensions: 120 x 45 x 4 mm</p>	1	R307823

FLEXkanal, Flexible Wiring Duct



FLEXkanal, Flexible Wiring Duct

Leading your cables safely to the desk. Connecting the desk box with the trunking or the floor connection box. Split in two channels for integral order separation.

Capacity per channel:
 2 cables Ø 8.5 mm or
 3 cables Ø 7.5 mm or
 4 cables Ø 7.0 mm or
 5 cables Ø 6.0 mm

Ordering Information

Description

Packing Unit

Part Number



Flexible Wiring Duct of 2 Channels

Available in various colours.
 Fully extended, length 1 m .

FLEXkanal, 1 m, grey-black	1	R302724
FLEXkanal, 1 m, light gray	1	R307688
FLEXkanal, 1 m, white	1	R307689
FLEXkanal, 1 m, red	1	R307976
FLEXkanal, 1 m, ultramarine	1	R307690
FLEXkanal, 1 m, yellow	1	R307831
FLEXkanal, 1 m, yellow/grey-black	1	R307830

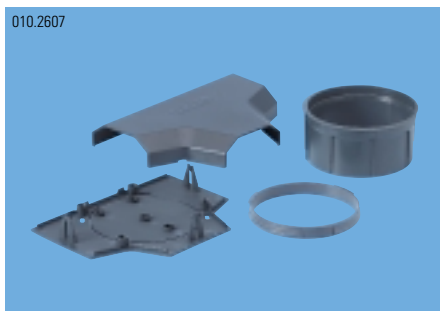

FLEXkanal Hollow Floor Cable Grommet

Cable outlet for a milled cutout of 95 mm in diameter, complete with T-distributor.
 Cutout: diameter 95 mm, height: 44 mm, color: anthracite (RAL 7024)

10

R307699

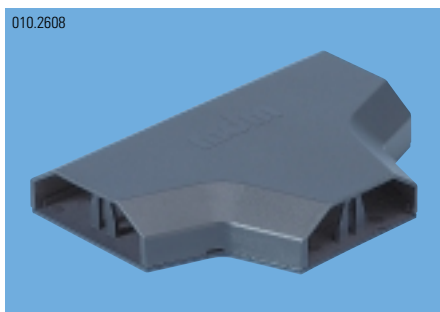

FLEXkanal T-Distributor, anthracite

T-distributor for the workstation power supply.

10

R307703



Blind Cover for Cable Grommet

Blind cover of 95 mm in diameter for the FLEXkanal cable grommet, to cover unused passages.

10

R307829

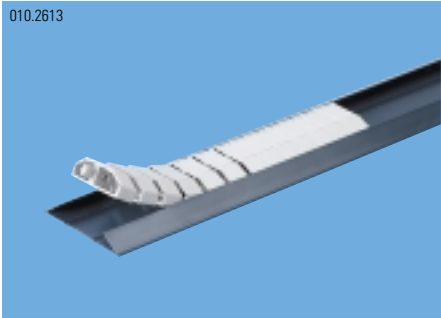
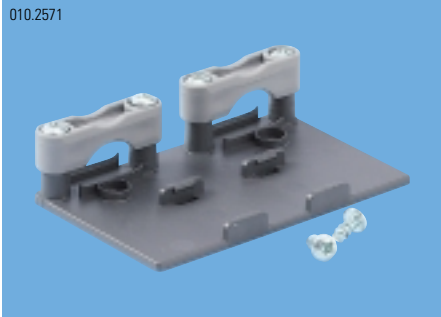
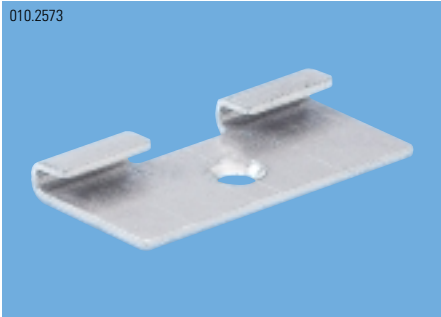
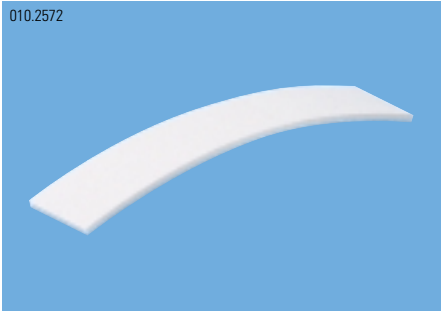
Ordering Information	Description	Packing Unit	Part Number
<p>010.2613</p> 	<p>FLEXkanal Floor Rail The floor rail is fastened to the floor and the FLEXkanal pressed in. The side protections minimize the tripping risk.</p> <p>FLEXkanal Floor Rail 1 m, anthracite FLEXkanal Floor Rail 2 m, anthracite</p>	<p>10 10</p>	<p>R307700 R307701</p>
<p>010.2571</p> 	<p>FLEXkanal Holder with Double Strain Relief The FLEXkanal is directly mounted to the holder. Fastened with screw.</p>	<p>10</p>	<p>R307476</p>
<p>010.2573</p> 	<p>FLEXkanal Support, aluminum The FLEXkanal is simply laid into the guiding brackets. Fastened with a countersunk screw.</p>	<p>10</p>	<p>R307696</p>
<p>010.2572</p> 	<p>FLEXkanal, 3M Adhesive Tape Double-sided adhesive tape. Dimensions: 15 x 28 mm</p>	<p>10</p>	<p>R307697</p>

Cable Management Panel

Ordering Information

Description

Packing Unit

Part Number

010.2602

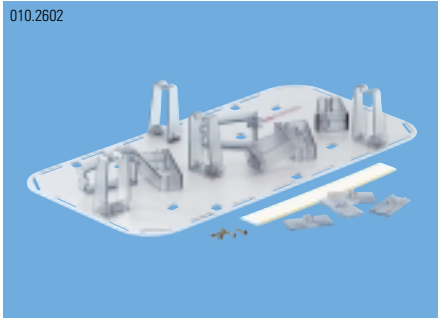

Cable Management Panel

Excess cable deposit positioned underneath the work desk. Accommodates up to 6 m data cables and up to 3 m of power cables. The panel can be taped on or screwed on.

Dimension: 400 x 200 mm

Supplied:

- Panel
- 10 brackets
- 4 mounting frames
- 4 screws, 3.5 x 20 mm
- 20 cm of adhesive tape

1

R307702

010.2609

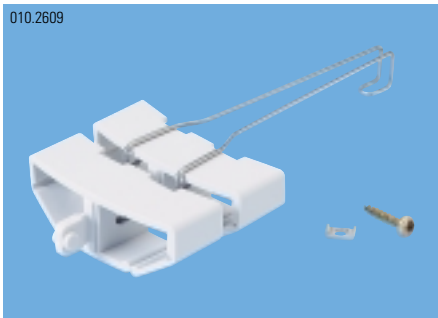

Flexible wing Duct Suspender

Suspends the FLEXkanal, connecting it with the cable management panel. Can also be screwed on underneath the desk.

10

R307694



090.2024.1

DESKbox

Ideal for use at the workplace, conference rooms or as connection point in double floors. Combined with the FLEXkanal they offer a neat solution all the way to the desk. Available in various transparent colors and in anthracite.

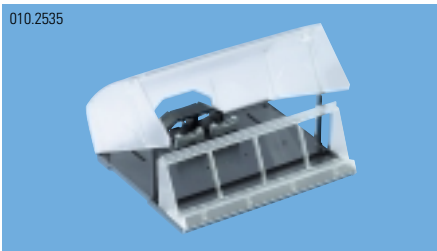

010.2535

Strain Relief

The holder for the FLEXkanal is assembled with a double strain relief and a FLEXkanal link, black.

Ordering Information

Description

Packing Unit

Part Number

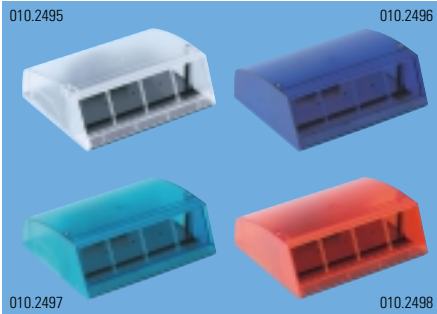

DESKbox, empty

Empty box ready to accommodate 4 devices (45 x 45mm). Cable entry in the center/side through FLEXkanal holder (double strain relief) and FLEXkanal link, anthracite.
Dimensions: 184 x 148 x 59 mm
For 4 devices 45 x 45 mm

- DESKbox 4 x 45 x 45, empty, clear** 1
- DESKbox 4 x 45 x 45, empty, blue** 1
- DESKbox 4 x 45 x 45, empty, green** 1
- DESKbox 4 x 45 x 45, empty, orange** 1
- DESKbox 4 x 45 x 45, empty, anthracite** 1

- R307791
- R307792
- R307793
- R307794
- R309571

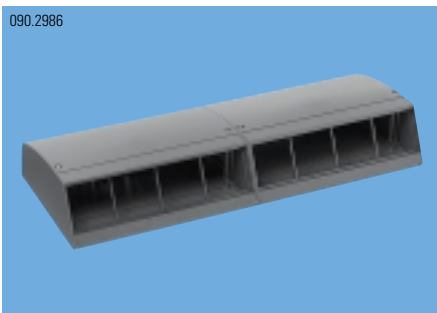

090.2986

DESKbox, empty

Ready to accommodate 8 devices (45 x 45 mm).
Dimensions: 368 x 148 x 59 mm
For 8 devices 45 x 45 mm

- DESKbox 8 x 45 x 45, empty, clear** 1
- DESKbox 8 x 45 x 45, empty, blue** 1
- DESKbox 8 x 45 x 45, empty, green** 1
- DESKbox 8 x 45 x 45, empty, orange** 1
- DESKbox 8 x 45 x 45, empty, anthracite** 1

- R307797
- R307798
- R307799
- R307800
- R309709

DOUBLE DESKbox Mounting Options Module 45					Accessories	
Schuko	Type 13	Belgian/ French	British	RJ45 faceplates	Connection modules	FO adapters
090.2089	090.2091	090.2088	090.2090	010.2574.1	010.2859	020.0070
◊ ◆ ◆ ◆	◊ ◆ ◆	◊	◊	◊ ◆	010.2857	010.2158
					Page 36/37	Page 46

DESKbox

Ordering Information	Description	Packing Unit	Part Number
010.2521 	Completely assembled box with 4 sockets Schuko/white. Cable entry in the center/side through FLEXkanal holder (double strain relief) and FLEXkanal link, anthracite.		
	DESKbox 4 x Schuko, clear	1	R307801
	DESKbox 4 x Schuko, blue	1	R307802
	DESKbox 4 x Schuko, green	1	R307803
	DESKbox 4 x Schuko, orange	1	R307804
010.2525 	Completely assembled box with 3 sockets Schuko/white and 2 holders/white for modules with single support plates. Cable entry in the center/side through FLEXkanal holder (double strain relief) and FLEXkanal link, anthracite.		
	DESKbox 3 x Schuko/2 x RJ45, clear	1	R307787
	DESKbox 3 x Schuko/2 x RJ45, blue	1	R307788
	DESKbox 3 x Schuko/2 x RJ45, green	1	R307789
	DESKbox 3 x Schuko/2 x RJ45, orange	1	R307790
010.2529 	Completely assembled box with 2 sockets Schuko/orange and 4 holders/white for modules with single support plates. Cable entry in the center/side through FLEXkanal holder (double strain relief) and FLEXkanal link, anthracite.		
	DESKbox 2 x Schuko/4 x RJ45, clear	1	R307805
	DESKbox 2 x Schuko/4 x RJ45, blue	1	R307806
	DESKbox 2 x Schuko/4 x RJ45, green	1	R307807
	DESKbox 2 x Schuko/4 x RJ45, orange	1	R307808
010.2533 	Completely assembled box with 4 sockets/white, 2 sockets Schuko/orange and 4 holders/white for modules with single support plates. Cable entry in the center/side through FLEXkanal holder (double strain relief) and FLEXkanal link, anthracite.		
	DESKbox 4 x white/2 x Schuko and 4 x RJ45, clear	1	R307971
	DESKbox 4 x white/2 x Schuko and 4 x RJ45, blue	1	R307973
	DESKbox 4 x white/2 x Schuko and 4 x RJ45, green	1	R307974
	DESKbox 4 x white/2 x Schuko and 4 x RJ45, orange	1	R307975

i On request all the boxes are supplied equipped and wired.

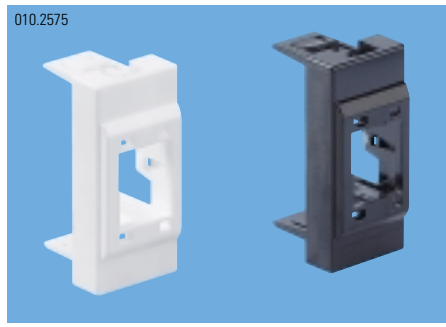
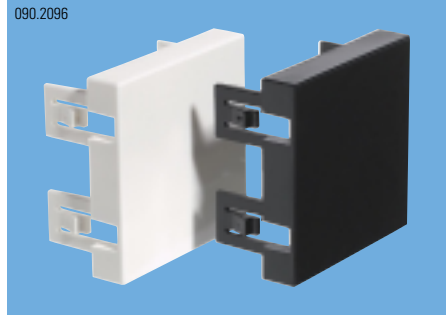
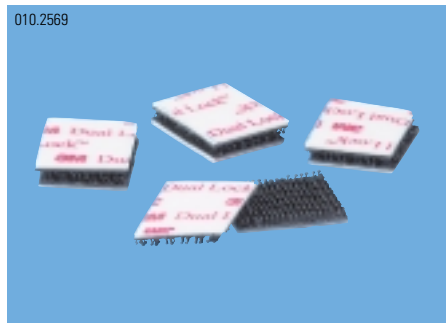
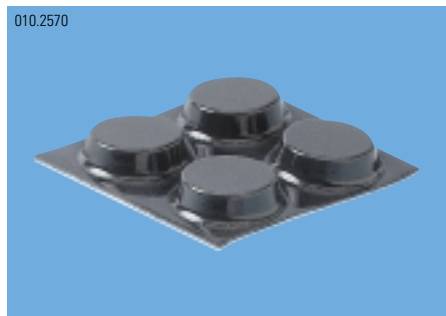
Ordering Information	Description	Packing Unit	Part Number
<p>010.2575</p> 	<p>Faceplates for 1 x RJ45 R&Mfreenet Available in black or white. Without module. Dimensions: 22.5 x 45 mm 1 x RJ45 R&Mfreenet, white, 22.5 x 45 mm 1 x RJ45 R&Mfreenet, black, 22.5 x 45 mm</p>	<p>10 10</p>	<p>R307835 R307837</p>
<p>010.2574</p> 	<p>Faceplates for 2 x RJ45 R&Mfreenet Available in black or white. Without module. Dimensions: 45 x 45 mm 2 x RJ45 R&Mfreenet, white, 45 x 45 mm 2 x RJ45 R&Mfreenet, black, 45 x 45 mm</p>	<p>10 10</p>	<p>R307834 R307959</p>
<p>090.2096</p> 	<p>Blind Faceplate Blind cover Blind Faceplate 45 x 45 mm, white Blind Faceplate 45 x 45 mm, black Blind Faceplate 22.5 x 45 mm, white Blind Faceplate 22.5 x 45 mm, black</p>	<p>10 10 10 10</p>	<p>R307960 R309170 R307961 R309169</p>
<p>010.2569</p> 	<p>3M Dual Lock 25 x 25 mm, qty 2 To fasten the boxes onto, or underneath, the workplace.</p>	<p>1</p>	<p>R307785</p>
<p>010.2570</p> 	<p>Plastic Bases, qty 4 Prevent the boxes from sliding on smooth surfaces.</p>	<p>1</p>	<p>R307786</p>